

# MINI POWER CONTROL SYSTEM

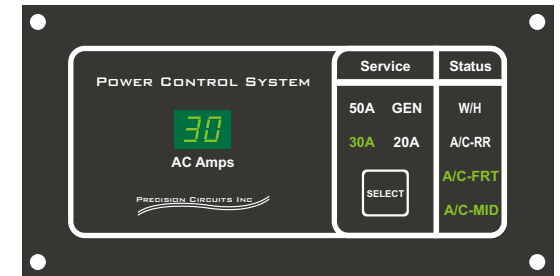

## DUTCHMEN WIRING DIAGRAM 02-28-2013

Exact Location of Breakers not Critical  
As long as Water Heater & A/C-RR are on  
opposite phases of Line Voltage.

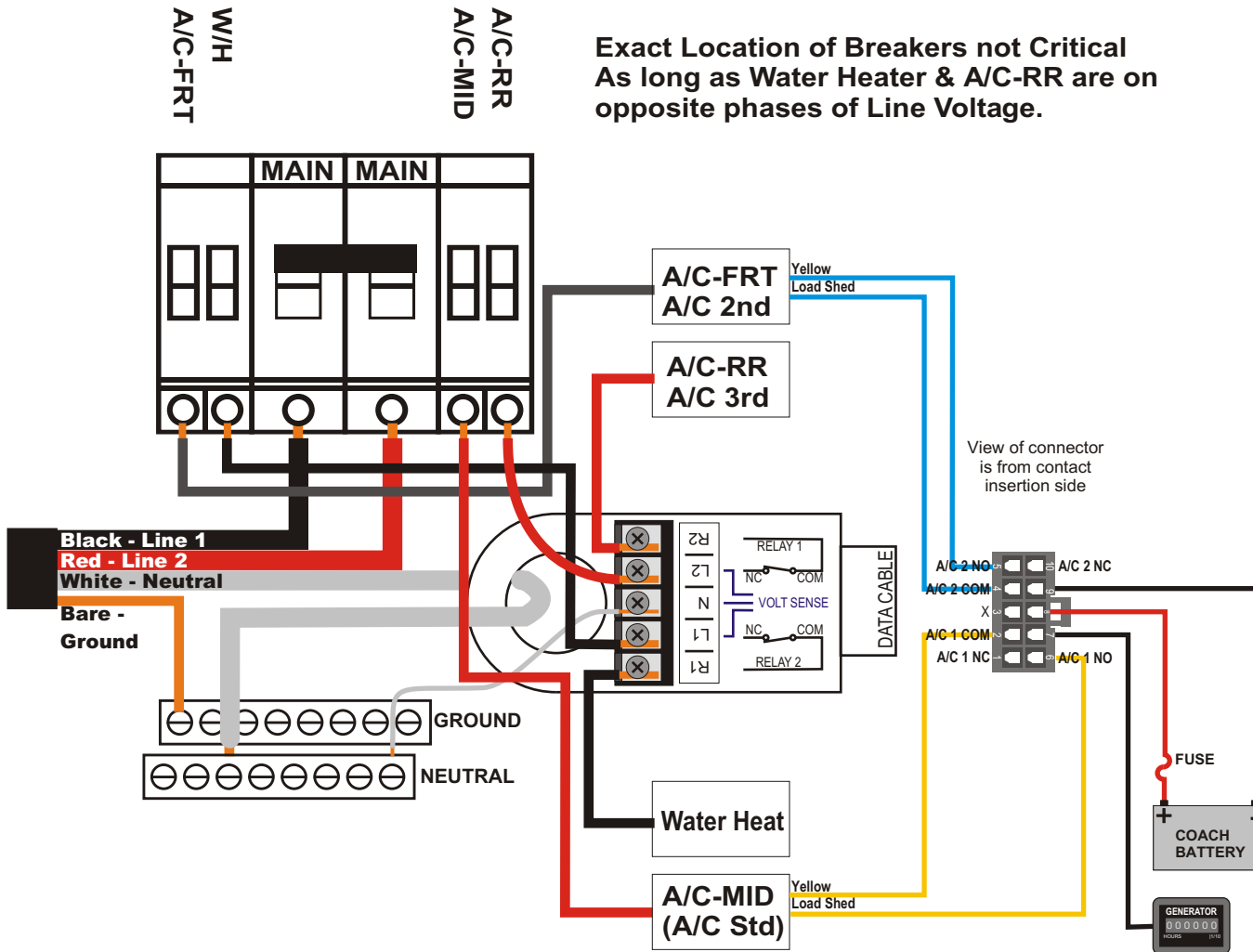

**Program Options:**  
**Relay Shed Order:**  
 1-W/H  
 2-A/C-RR  
 4-A/C-FRT  
 3-A/C-MID  
 50A Service = Sleep Mode  
 Generator = Amp Display Only