

# MINI POWER CONTROL SYSTEM

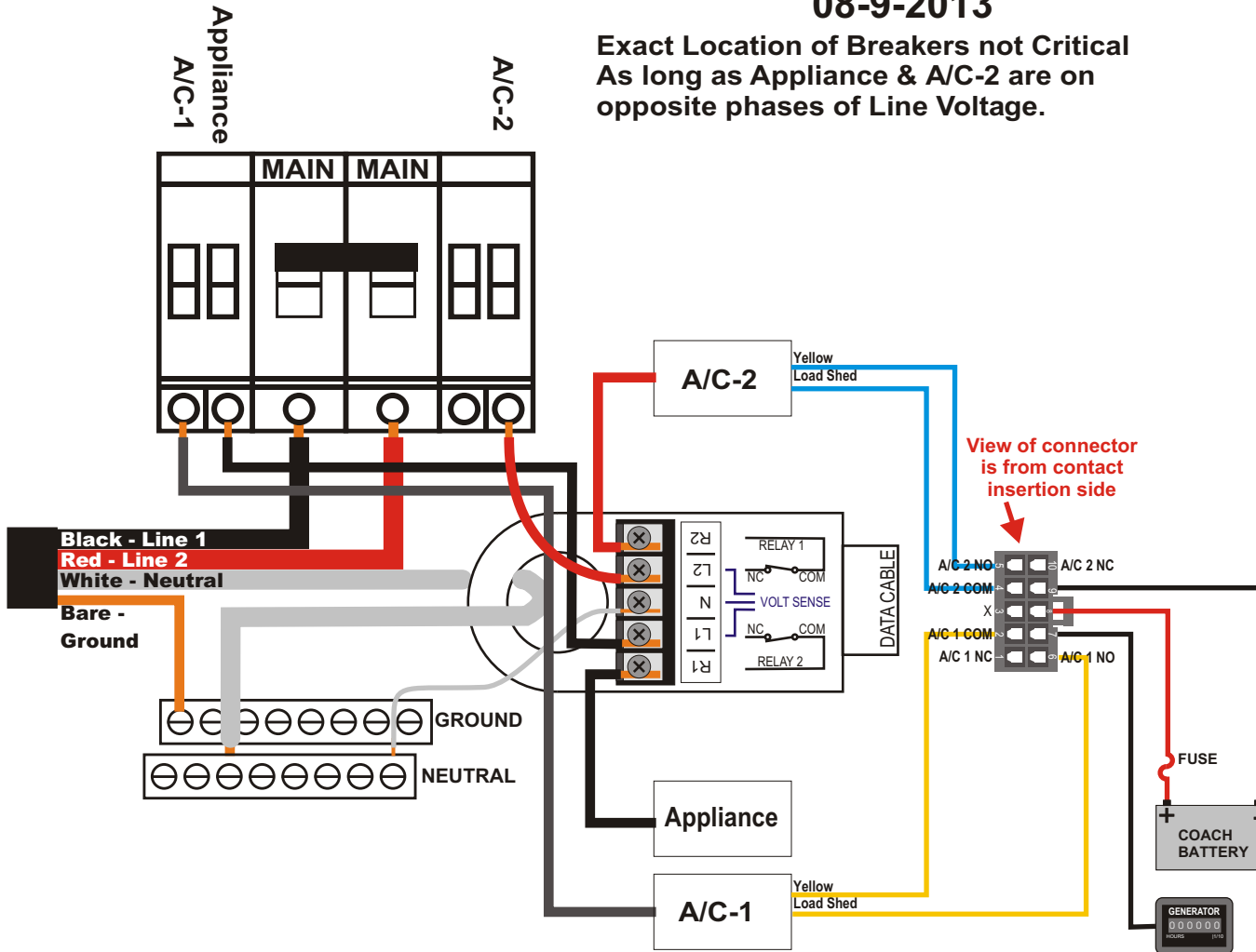

## Creative Mobile WIRING DIAGRAM 08-9-2013

Exact Location of Breakers not Critical  
As long as Appliance & A/C-2 are on  
opposite phases of Line Voltage.



Model 220 Program Options:

Relay Shed Order = 1-Appliance

4-A/C-2 (Compressor Only)

2-A/C-2 Fan (all 120V power)

3-A/C-1 (Compressor Only)

50A = Sleep Mode

GEN = 45A Current Limit, Shed Loads  
(5500W Generator)

